

NEW SMART MODELS !

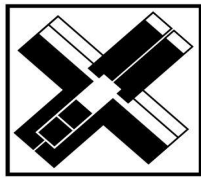

poliangolar®

MINIMO SPAZIO, MASSIMA PRECISIONE



COMPACT MODELS, HIGH PERFORMANCE

<https://brootsen.com/poliangolar/>

POLIANGOLAR MOD. MICRO04



Modello	MICRO 04	Model
Profondità di lavoro	≤4 mm	Max. working depth
Peso	35 g	Weight
Capacità su profili esagonali	≤3 mm	Capacity for hexagonal profiles
Capacità su profili quadrati	≤2,5 mm	Capacity for square profiles
Capacità su profili Torx	≤T8	Capacity for Torx profiles
Utensile	NG04	Tool Model
Attacchi disponibili	Ø (6-7-8-10)	Type of shank

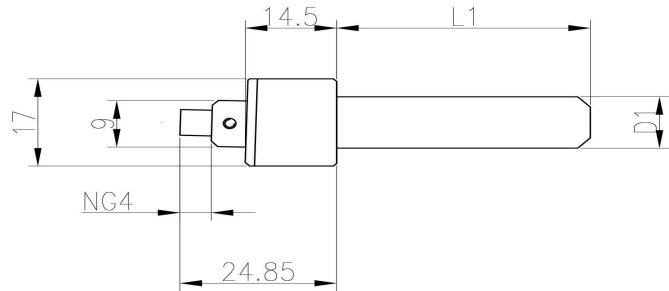

I nuovi modelli compatti sono particolarmente adatti ad essere montati su macchine fantina mobile e macchine automatiche di piccole dimensioni, dove è richiesto un ingombro ridotto.

New compact models are specifically designed for use on Swiss style lathes or automatic machines where small overall dimensions are required.

POLIANGOLAR MOD. 0100N

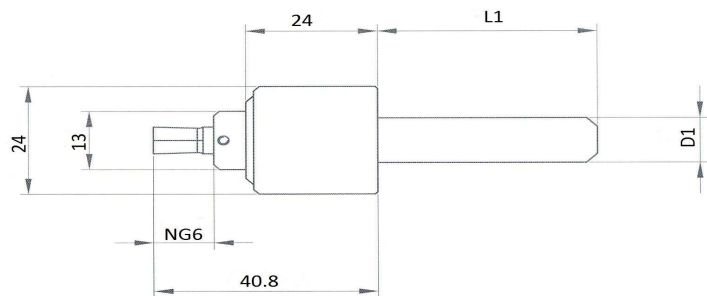

Modello	0100N	Model
Profondità di lavoro	≤10 mm	Max. working depth
Peso	150 g	Weight
Capacità su profili esagonali	≤5 mm	Capacity for hexagonal profiles
Capacità su profili quadrati	≤4 mm	Capacity for square profiles
Capacità su profili Torx	≤T15	Capacity for Torx profiles
Utensile	NG06	Tool Model
Attacchi disponibili	Ø 6-7-8-10-12-16-3/4"-20-22-1"	Type of shank

<https://brootsen.com/poliangolar/>

POLIANGOLAR MOD. 0200N



Modello	0200N	Model
Profondità di lavoro	≤15 mm	Max. working depth
Peso	250 g	Weight
Capacità su profili esagonali	≤10 mm	Capacity for hexagonal profiles
Capacità su profili quadrati	≤8 mm	Capacity for square profiles
Capacità su profili Torx	≤T30	Capacity for Torx profiles
Utensile	NG08	Tool Model
Attacchi disponibili	Ø (10-12-16-3/4"-20-22-25-1"), Weldon(16-20-25), VDI20,BT20,ISO20, HSK40	Type of shank

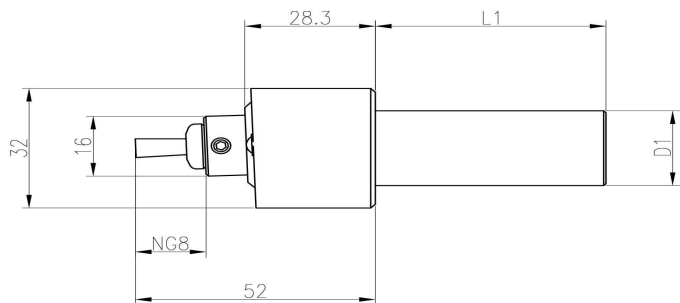

L'uso di cuscinetti altamente performanti permettono a questa gamma di apparecchi di eseguire cicli continui di produzione. L'utilizzo dei modelli compact risulta semplice e consente di produrre profili interni ed esterni lavorando i più svariati tipi di materiale.

These small toolholders are a simple and easy to operate solution for producing internal and external polygons in a variety of materials. They are equipped with high performance bearings thus permitting a continuous production cycle.

POLIANGOLAR MOD. 0200E

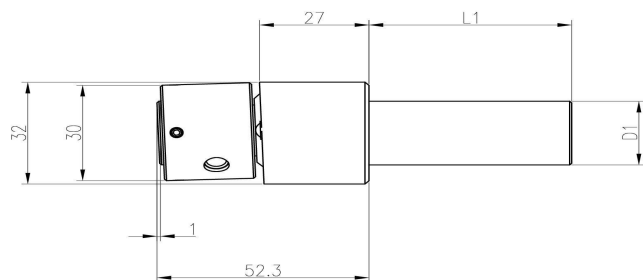

Modello	0200E	Model
Profondità di lavoro	≤15 mm	Max. working depth
Peso	250 g	Weight
Capacità su profili esagonali	≤10 mm	Capacity for hexagonal profiles
Capacità su profili quadrati	≤8 mm	Capacity for square profiles
Capacità su profili Torx	≤E8	Capacity for Torx profiles
Utensile	EG20	Tool Model
Attacchi disponibili	Ø (10-12-16-3/4"-20-22-25-1"), Weldon(16-20-25), VDI20,BT20,ISO20, HSK40	Type of shank

<https://brootsen.com/poliangolar/>

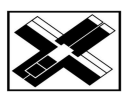
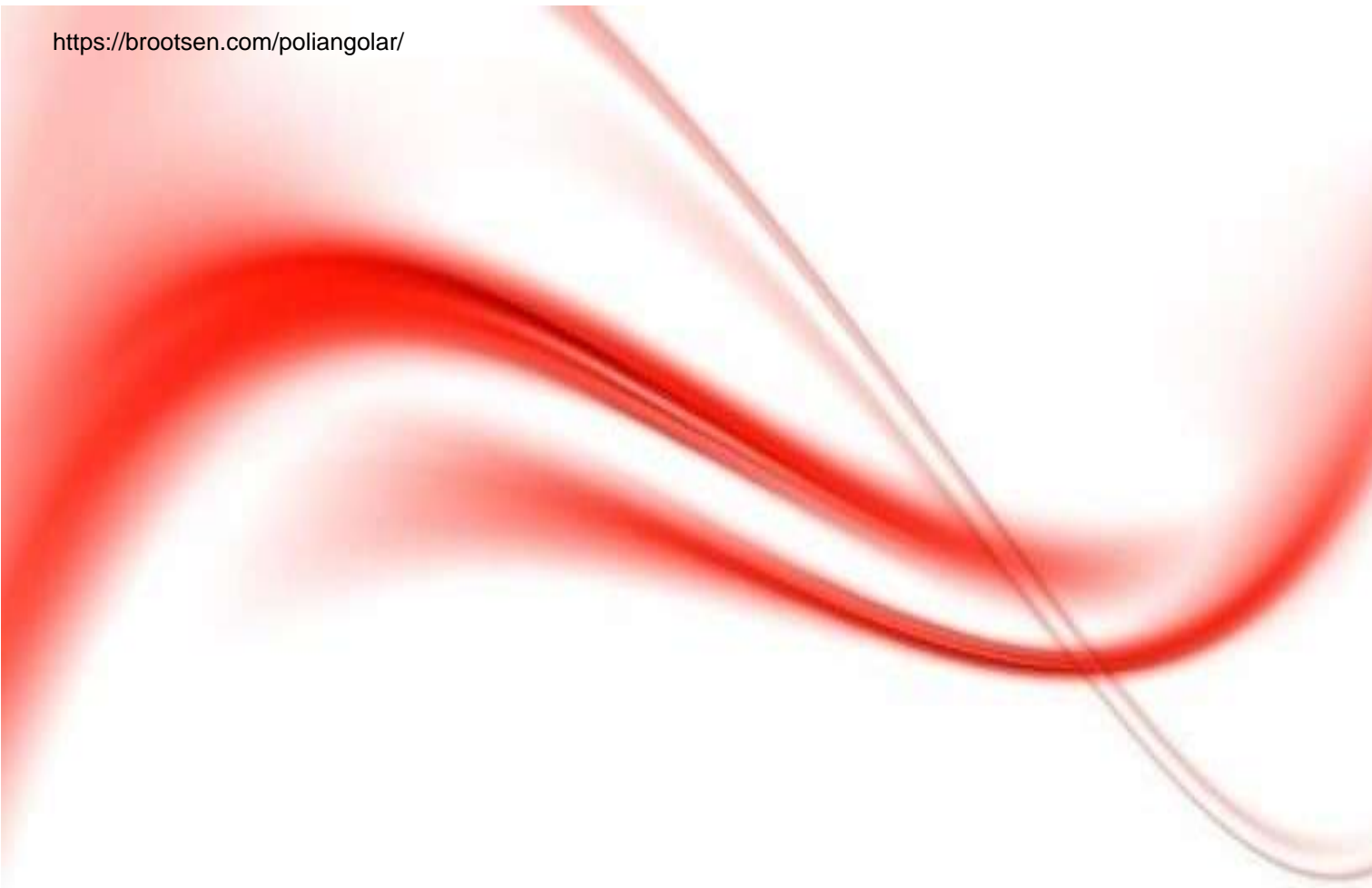

poliangular[®]